

# وبلاگ نظارت و ایمنی کارگاه



---

وبلاگ نظارت و ایمنی کارگاه

## OBJECTIVE OF THIS MODULE

Outline areas that need to be considered in order that maximum control is applied where there is a risk of

Worker/s falling

Materials falling

Handrails are possibly the most used form of fall prevention on construction sites.

They are relatively easy to install and offer highly acceptable protection.

This Module will give you a basic understanding of where and when it would be acceptable to use handrails and what the expected standard is.



Handrails are acceptable as fall prevention where there is any fall edge.

Whether this be on a building (no matter what the height) or on the ground to protect around an excavation area.

A handrail consists of:

**Standards**

**Mid rail**

**Top rail**

**Kickboard**

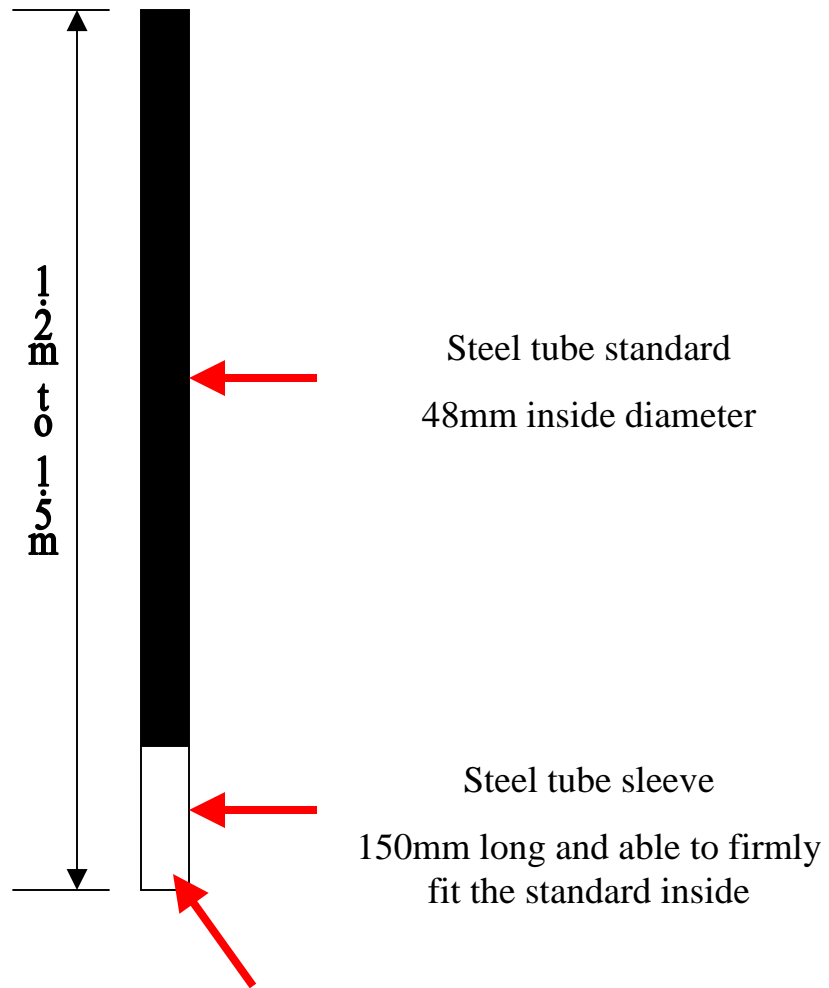

If steel frame building, the sleeve is to be welded to beam on the ground prior to being lifted onto building.

Sleeves are to be welded to steel beam, on ground prior to lifting on to the building and cast into floor slab. Ensure the sleeve height is higher than slab depth.

Where the above cannot be achieved, the sleeve is to be welded to a steel plate, no smaller than 100mm square and secured to completed slab with expansion bolts.

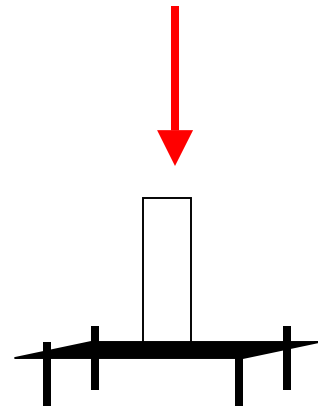

Standards and sleeves are to be no further than 2m apart. They are to be installed PLUMB.

1

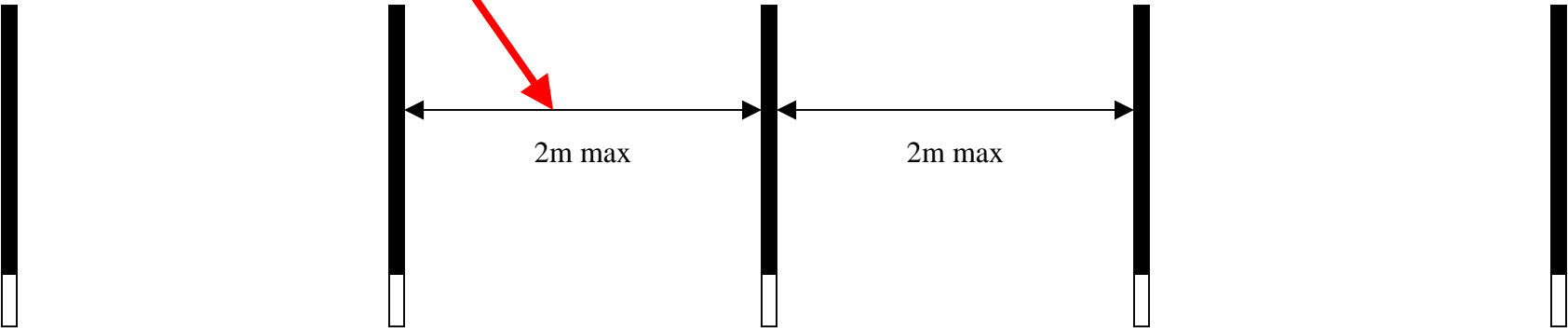

Top rail to be secured at, between 1.0m & 1.2m. Rail to be secured to standards with a (NON-SWIVEL) scaffold fitting. Rail to be installed LEVEL.

2

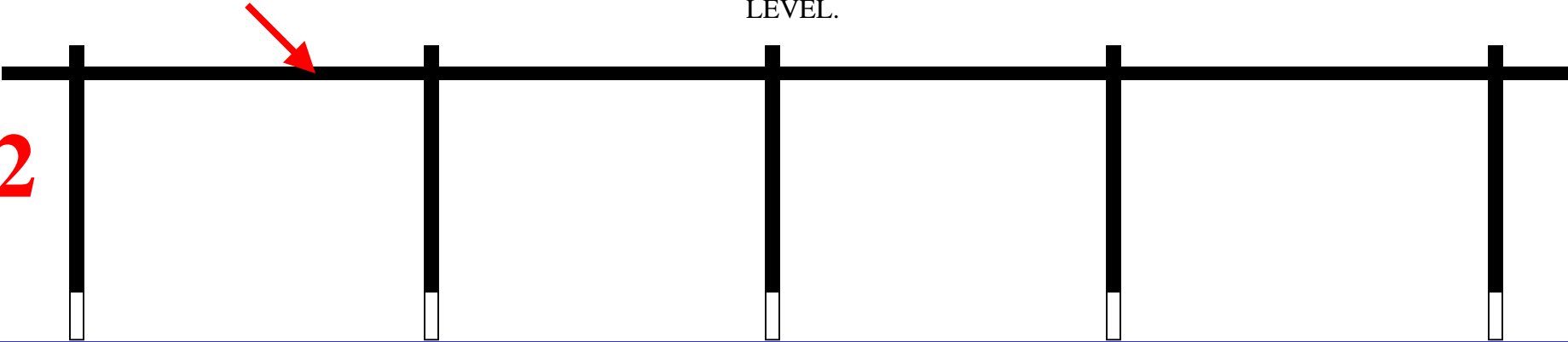

Mid rail to be secured exactly half of height of top rail

3

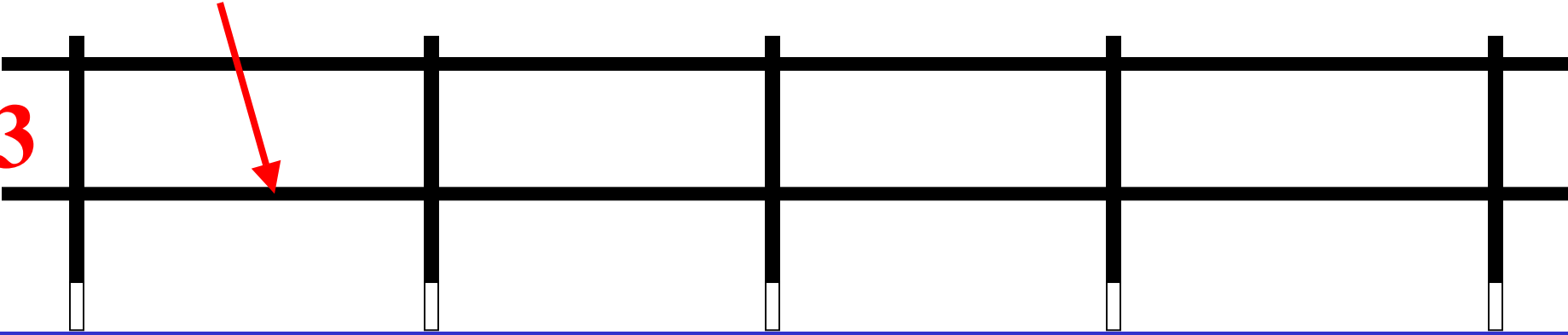

Kickboard (150mm minimum height) to be secured to standards.

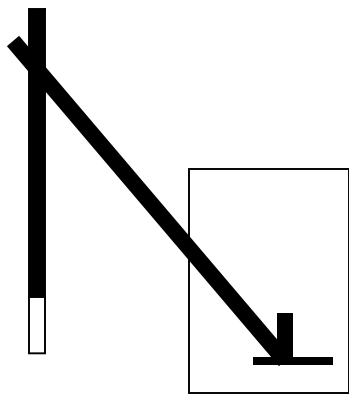
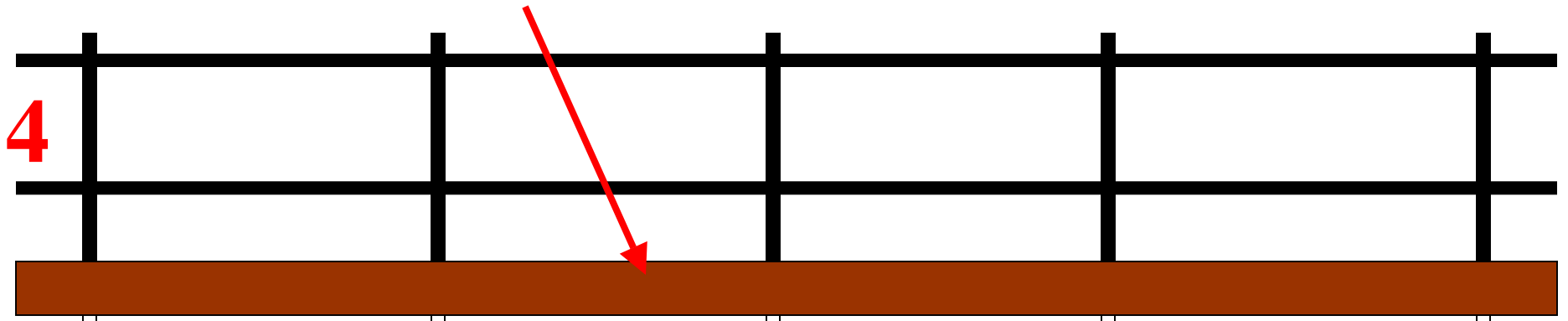

Continuous handrails longer than 10m MUST be stayed every 10m as well as at both ends. The stay is to brace from the fall edge side back to top rail.

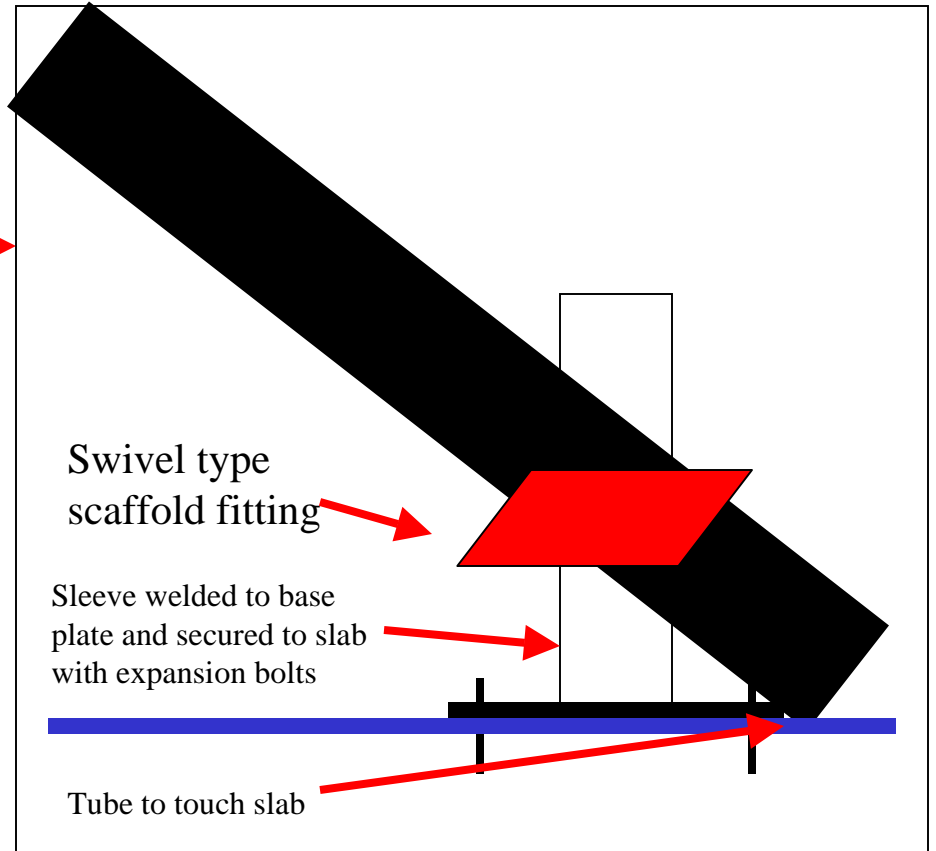



Over a length of 17m you will need stays @ start, 10m & end.

It is acceptable for this stay to be located mid-way if run is under 20m

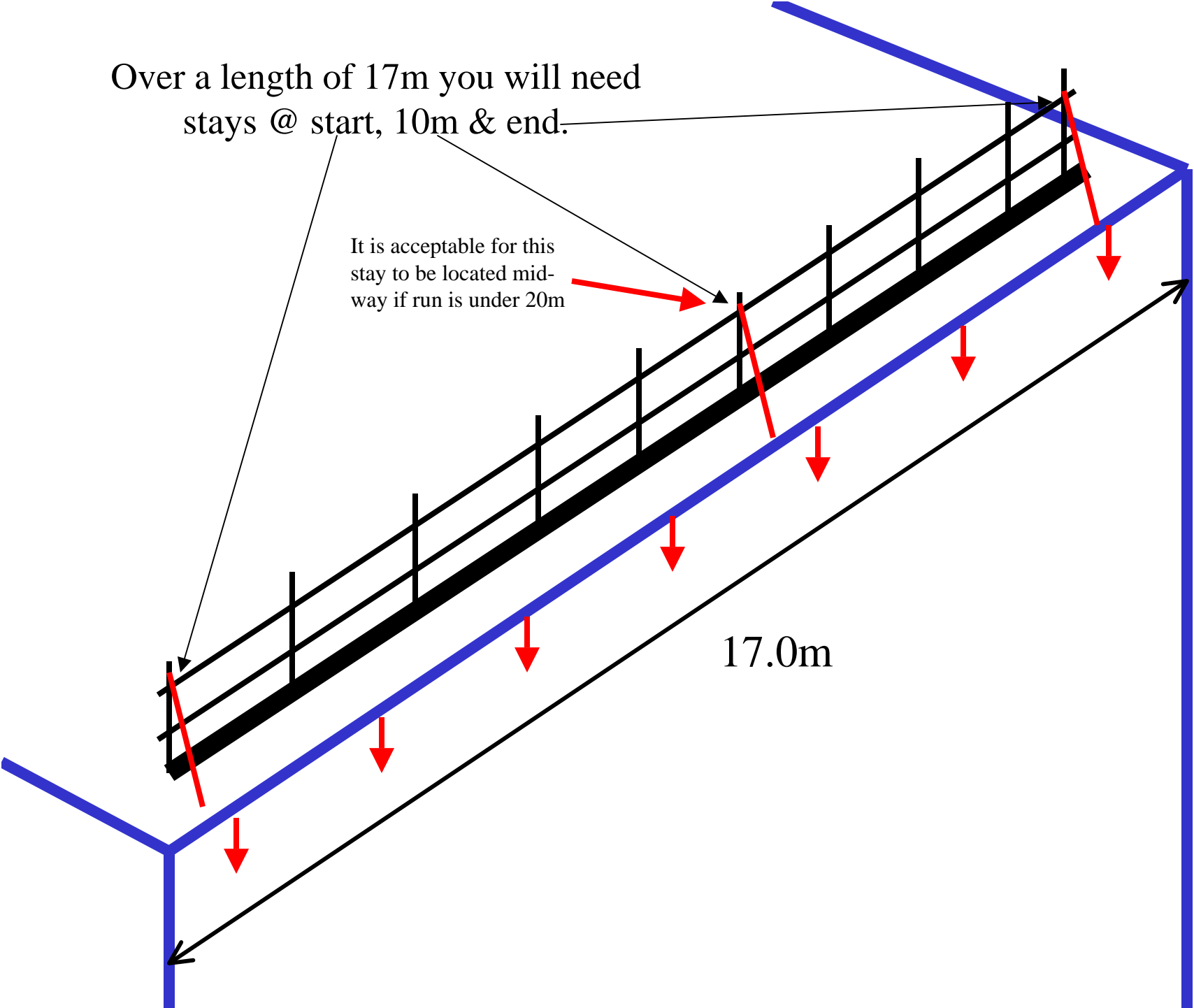

17.0m

If both ends have return hand rails that are connected, then the need for end stays is eliminated.

It is acceptable to position stay at the halfway point

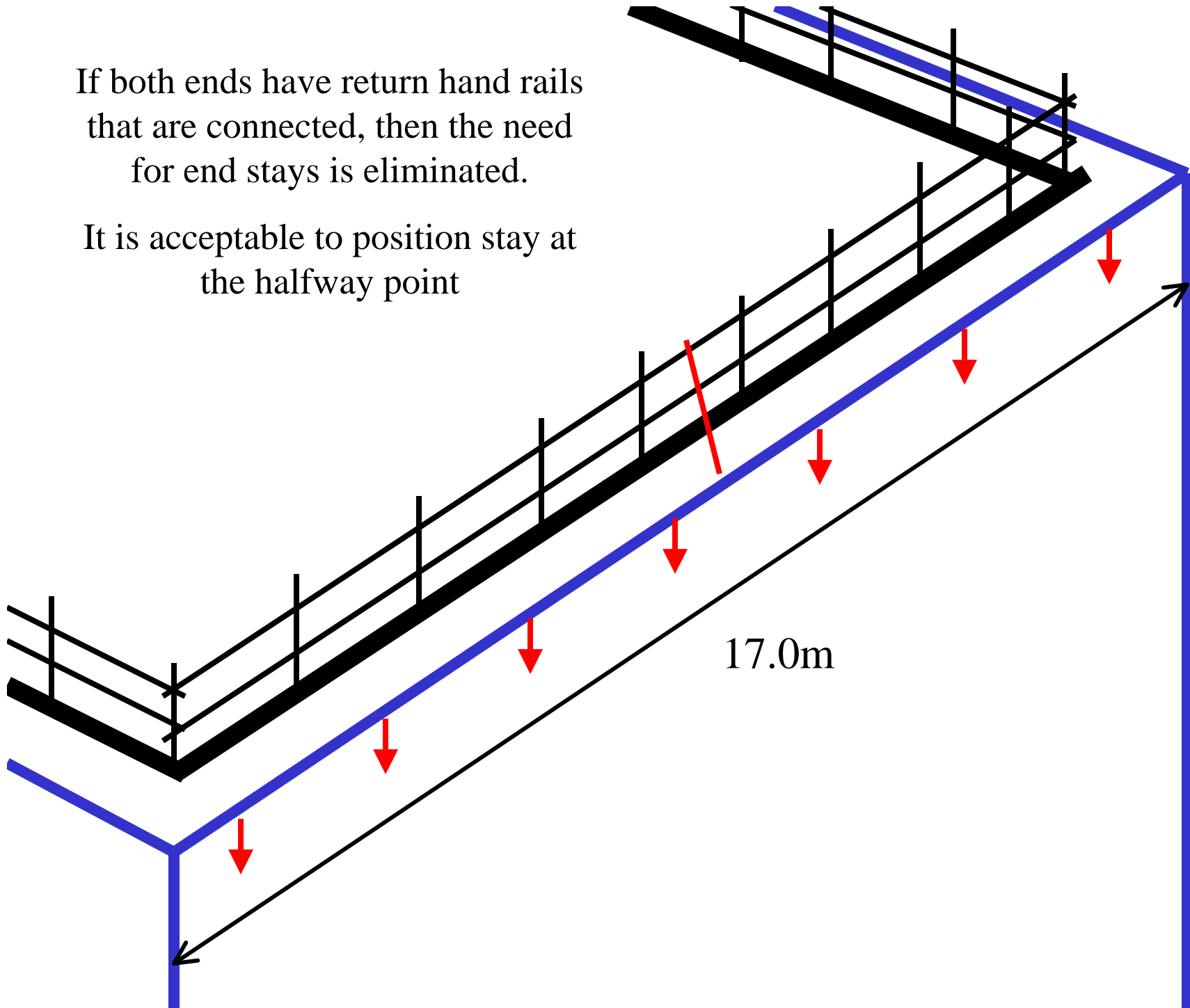

Stay's are also not required if the handrail is located non-fall edge side of columns. (handrail must touch columns)

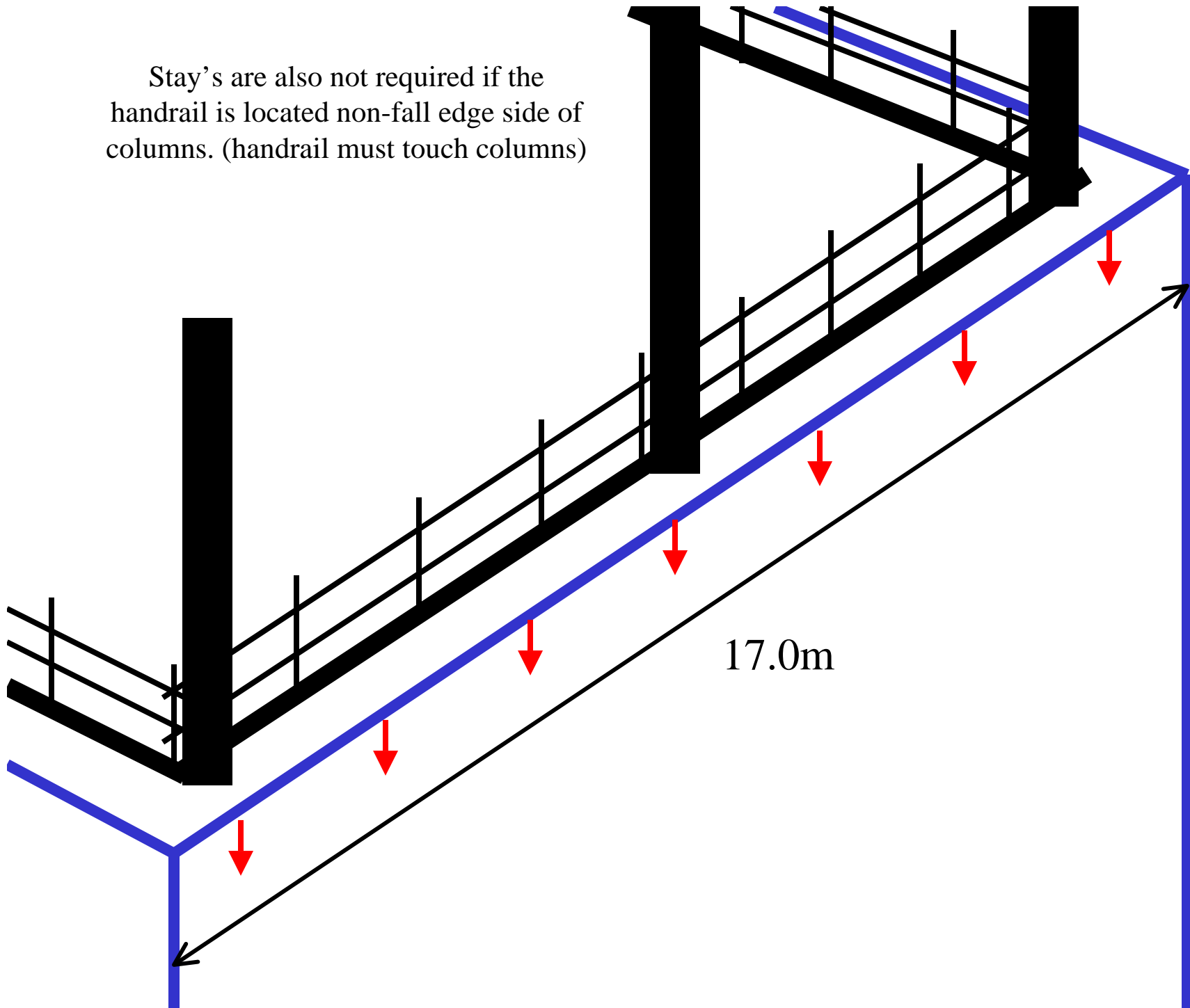

17.0m

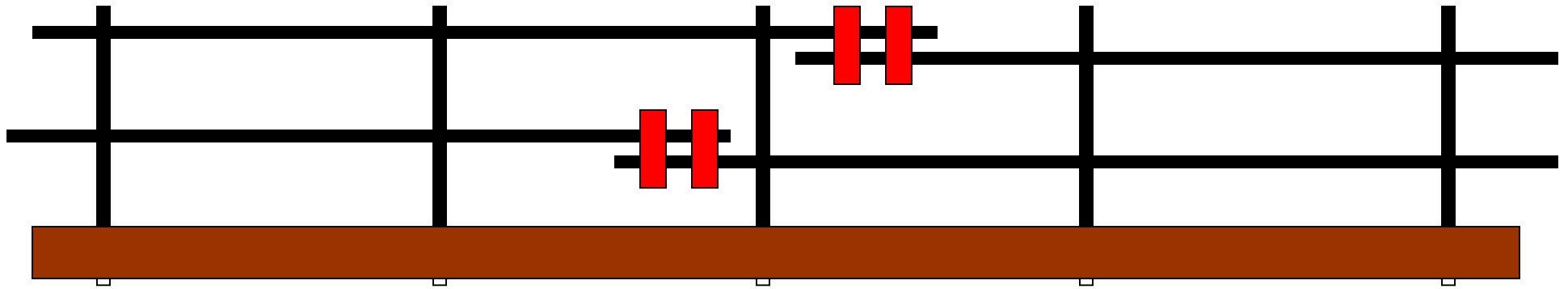

If tube connectors are not available to join lengths of tube for rails, then the above is to be adopted. Run one rail above the other and connect with swivel scaffold fittings (minimum of 2). Try to refrain from joining top and mid rails in the same bay.



Alternate the next join so that rails don't keep stepping up or down.

Where you need to erect handrails in the ground, either ensure standard is driven at least 300mm

OR

150mm and SET IN concrete

Remember to follow the stay procedure for longer runs of handrails



**Handrails are often used by personnel to tie off too**

**LOAD STRENGTH STANDARD REQUIREMENT**

**250KG DEAD WEIGHT**

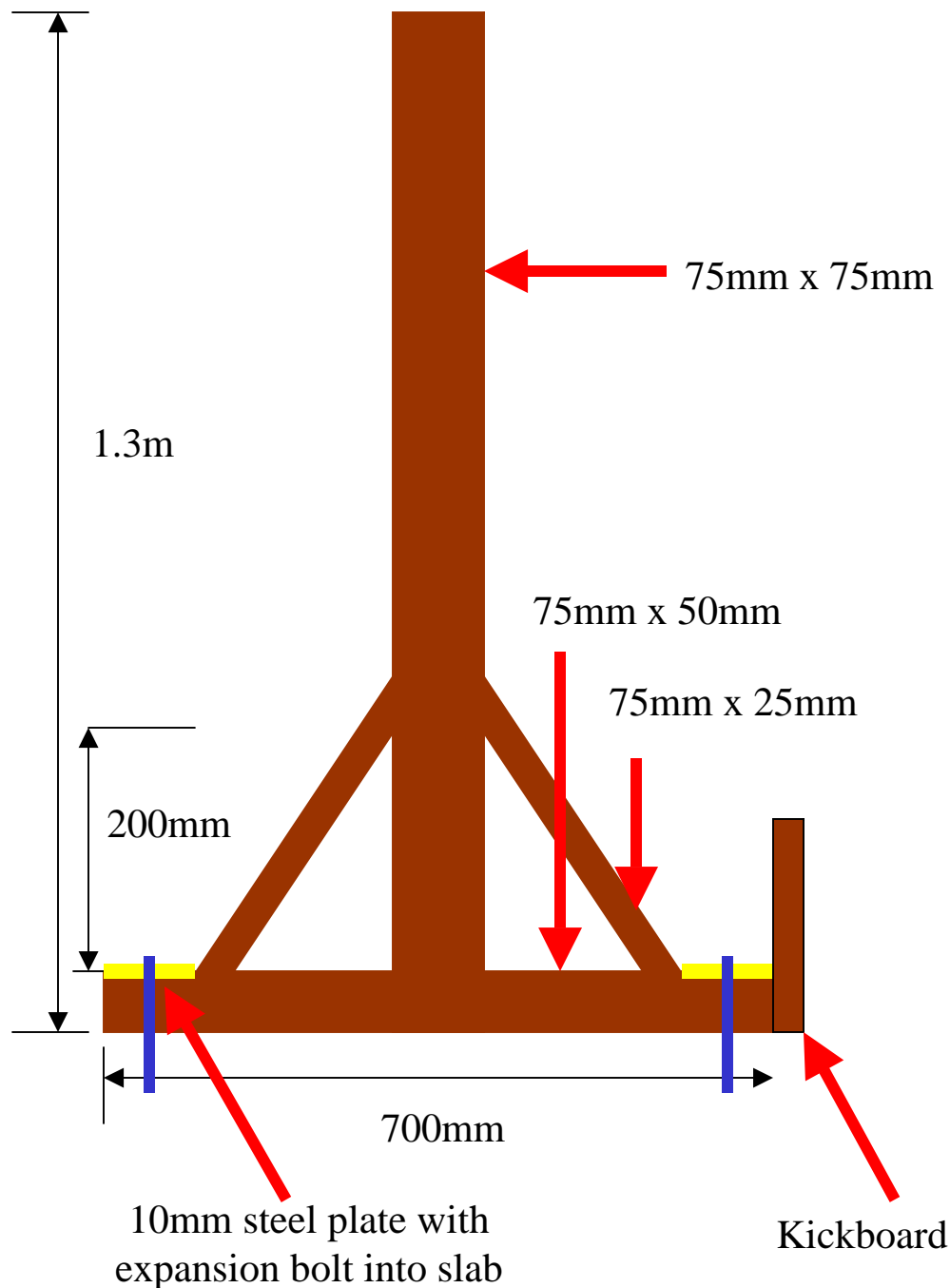

Wooden handrails are permitted BUT must comply to this standard.

Posts to be constructed as illustrated. Components to be screwed, NOT nailed.

Rails to be (min) 75mm x 25mm (screwed to posts) Rails MUST join at posts (not in the middle of a bay. Top of top rail between 1.0m and 1.2m and mid rail, half of that + height of kickboard.

Kickboard must be installed.

Posts MUST be secured to slab with expansion bolt. If being installed on ground, pegs made from re-bar can be driven into ground 300mm (min) in replacement of expansion bolt. NOTE: Even if re-bar is being used, the 10mm plate MUST accompany.

**SIDE VIEW**

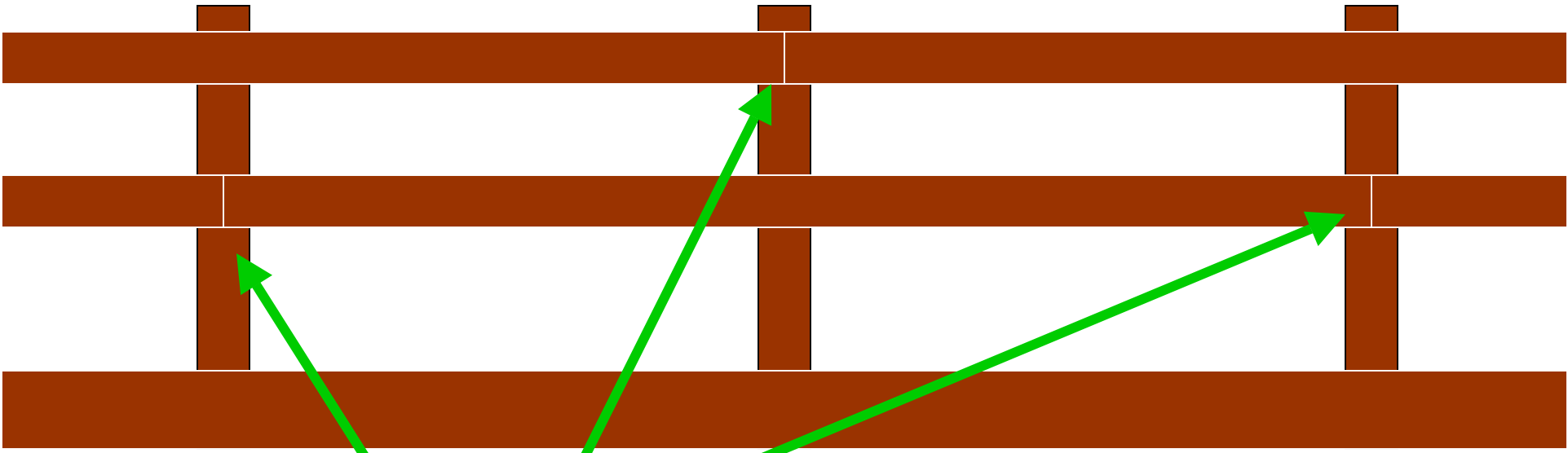

**CORRECT**

**WRONG**

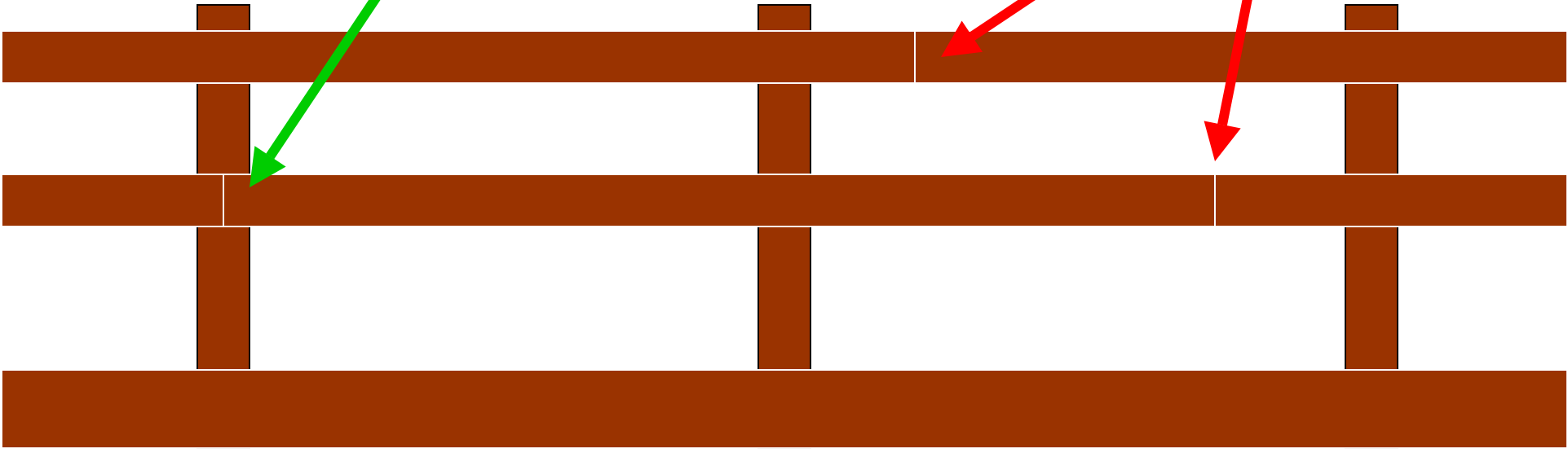

# Handrails

**The standards outlined in this MODULE are minimum standard.**

Where possible handrail post/standards to be positioned 1.0m away from fall edge.

Handrails to be erected to withstand a dead weight of 250kg.

Re-bar, rope, wire cable, warning tape or any other foreign material are not permitted as handrail or edge protection where a 2m or greater edge is being protected.

Barricades and fencing (in their traditional form) are not permitted as handrail or edge protection where a 2m or greater edge is being protected.

Handrails to be erected PLUMB and LEVEL.

The use of swivel type scaffold fittings to connect rails to standards is NOT permitted.

Tube type to be 48mm (internal diameter) steel tube.

Sleeves to take tube standards with a snug fit. (the use of foreign material to firm up the fit is not preferred)

All other component dimensions, standards and guidelines contained within this Module are to be adopted as the minimum standard.

---

---



## وبلاگ نظارت و ایمنی کارگاه

---

---

---

---

---

---

---

---

---

---

---

---

---

---